



Rechargeable Smart Lithium Ion Battery

SE-2054-1



User's Manual

Reference Part Numbers for Battery Model SE-2054-1

SE20541NR29

14.4V 2.85AH, 41.04Wh



Statement of Confidentiality

The information contained within this document is confidential and proprietary to Sealed Energy Systems. This information should not, in whole or in part, be reproduced, disclosed or used except as expressly and duly authorized by Sealed Energy Systems.





TABLE OF CONTENTS

1. REVISION HISTORY	3
2. INTRODUCTION	3
2.1. SCOPE	3
2.2. BATTERY PACK OVERVIEW	3
2.3. GENERAL PRECAUTIONS	4
2.3.1. Handling	4
2.3.2. Charge & Discharge	4
2.3.3. Storage	4
2.3.4. Disposal	5
2.3.5. Comply with Waste Regulation	5
3. REQUIREMENTS	6
3.1. GENERAL REQUIREMENTS	6
3.1.1. Nominal Voltage	6
3.1.2. Rated Capacity	6
3.1.3. Initial Impedance	6
3.1.4. Discharge	7
3.1.5. Charge	8
3.1.6. Storage	9
3.1.7. Terminal Specifications	9
3.2. FUEL-GAUGE ELECTRONICS	9
3.2.1. Overview of Operation	9
3.2.2. DC Specifications	11
3.2.3. Measurement Accuracy	11
3.3. SMBUS AND SBD PARAMETERS	12
3.3.1. Overview of Operations	12
3.3.2. SMBus Logic Levels	12
3.3.3. SMBus Data Protocols	12
3.3.4. SMBus Host-to-Battery Message Protocol	13
3.3.5. SMBus Battery-to-Charger Message Protocol	14
3.3.6. SMBus Battery Critical Message Protocol	15
3.3.7. Host to Battery Messages (Slave Mode)	15
3.3.8. Battery to Charger Messages (Master Mode)	17
3.3.9. Critical Messages (Master Mode)	17
3.3.10. Pack Calibration Cycle	19
3.4. PROTECTION ELECTRONICS	19
3.4.1. Overview of Operation	19
3.4.2. Charge Protection	19
3.4.3. Discharge Protection	20
3.4.4. Short-Current Protection	20
3.5. PASSIVE SAFETY PROTECTION	21
3.5.1. Overview of Operation	21
3.5.2. Thermal Fuse	21
3.6. MECHANICAL SPECIFICATIONS	21
3.6.1. Weight	21
3.6.2. Mating Connector	21
3.6.3. Packaging	21
3.7. ENVIRONMENTAL/SAFETY SPECIFICATIONS	21
3.7.1. EMC and Safety	21
3.8. RELIABILITY	22
3.8.1. Life Expectancy	22
3.8.2. Warranty	22
3.8.3. Shelf Life	23
4.0. MECHANICAL DRAWING	24



1. REVISION HISTORY

Revision	Release Date	Revisions	Issued	Approved
1.0	20/10/2019	Released	SES	MGM
1.1	03/01/2020	Certificate of Compliance issued on UN38.3 and IEC/EN 62281	NEMKO	MGM
1.2	08/01/2020	Certificate of compliance, REACH Ann-II of 2011/ 65/EU and adm EU 2015/863	INTERTEK	MGM
1.3	08/01/2020	Certificate of compliance, EU REACH Regulation no. 1907/2006 article 33(1) contents of all SCHV <0.1% w/w	INTERTEK	MGM
1.4	29/01/2020	BIS, Certificate of Registration issue on IS 16046-2:2018	INTERTEK	MGM
1.5	03/03/2020	Certificate of Compliance issued on IEC/EN 62133-2:2017	NEMKO	MGM

2. INTRODUCTION

2.1 Scope

This specification describes the physical, functional and electrical characteristics of a rechargeable Lithium Ion battery SE-2054-1 by Sealed Energy Systems (SES®). This specification is the interface document between SES® and its customers. It is understood that the customer may create their own internal specification. However, this specification is the master that defines the battery's operation.

2.2 Battery Pack Overview

This specification describes the physical, functional and electrical requirements for the SE20541NR29 Smart Battery including a rechargeable Lithium Ion battery and a Battery Management Module. The battery consists of four (04) Lithium Ion rechargeable cells of INR-18650 size, assembled in a 4 series / 1 parallel (4S1P) configuration. Each cell has an average voltage of 3.6V and a typical capacity of 2.85Ah giving a battery pack of 14.4V and 2.85Ah typical. The battery is capable of communicating with host or the charger through the System Management Bus (SMBus). The battery is fully SMBus and SBDS Revision 1.1 compliant. Protection is provided for over-charge, over-discharge and short circuit. For redundancy, passive safety devices have been integrated into the pack to protect against over-current and over-temperature, and secondary overvoltage has been implemented with a logic-fuse and controller.

The battery pack comprises the individual elements as shown below:

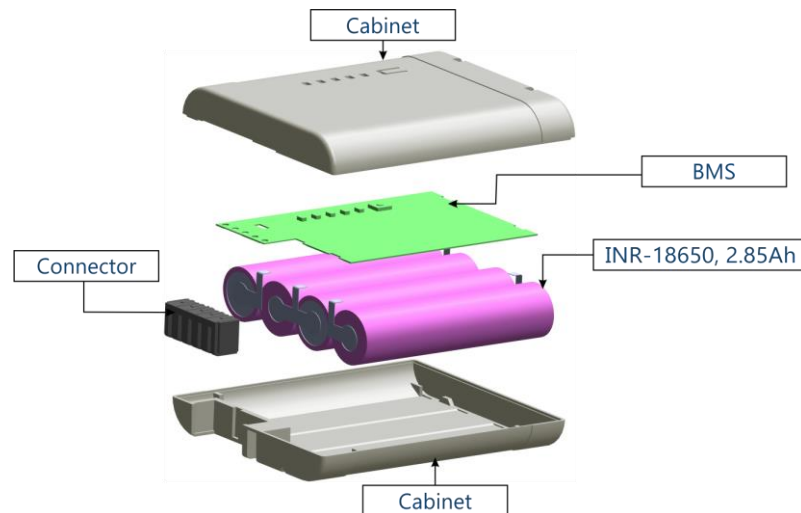

2.3 General Precaution

2.3.1 Handling

- Avoid shorting the battery. Do not immerse in water.
- Do not disassemble or deform the battery
- Do not expose to, or dispose of the battery in fire.
- Avoid excessive physical shock or vibration.
- Keep out of the reach of children.
- Avoid storage in direct sunlight.
- Do not short-circuit a battery.

- In the event of a battery leaking, do not allow the liquid to come in contact with the skin or eyes. If contact has been made, wash the affected area with copious amounts of water and seek medical advice. Keep batteries clean and dry.
- Secondary batteries need to be charged before use.
- When possible, remove the battery from the equipment when not in use.
- Do not store batteries longer than 1 month in discharged state. Do not storage batteries longer than 1 year without recharge.

2.3.2 Charge & Discharge

- Battery must be charged in appropriate charger only.
- Never use a modified or damaged charger.
- Specified product use only.
- Operating Temperature
 - For Charge: 0°C to +45°C
 - For Discharge: -20°C to +55°C

2.3.3 Storage

- Store in a cool, dry and well-ventilated area.
- Storage Temperature: -20°C to +45°C
- Recommender Storage Temperature 20°C ± 5°C



2.3.4 Disposal

- Regulations vary for different countries. Dispose of in accordance with local regulations.
- Intact, spent batteries are not considered to be hazardous waste.
- Waste Treatment Methods: Waste Li-Ion batteries meet the United States federal definition of a solid waste per 40 Code of Federal Regulations (CFR) 261.2. It is recommended that the batteries be recycled even though they can be disposed of in the garbage.
- Recycling: Waste Li-Ion batteries do not fall under any specific RCRA, F, K, P or U lists. The status of scrap Li-Ion batteries should be confirmed in the nation or US state where disposal occurs.

2.3.5 Comply with Waste Regulations:

India: Expended battery must be taken for recycling or disposal at an appropriate collection depot by suitably licensed contractors in accordance with state and center government regulations.

USA: Expended batteries are not considered hazardous waste. Cells and batteries involved in a fire may be considered to be hazardous waste. Dispose of in accordance with local, state and federal laws and regulations. Consult

universal/hazardous waste regulations for further information regarding disposal of spent batteries. If the internal cells are leaking/broken open, consult hazardous waste regulations under US Environmental Protection Agency's Resource Conservation and Recovery Act (RCRA), waste code: D003(reactivity). Also, consult state and local regulations for further disposal requirements.

Canada: Expended battery packs are not considered hazardous waste. Cells and batteries involved in a fire may be considered to be hazardous waste. Dispose of in accordance with local, provincial and federal laws and regulations. Consult the Canadian Environmental Protection Act for additional details.

EU: Expended battery pack waste must be disposed of in accordance with relevant EC Directives and national, regional and local environmental control regulations. For disposal within the EC, the appropriate code according to the European Waste Catalogue (EWC) should be used. EU Waste Code: 16 06 05 – other batteries and accumulators.

Australia: Expended battery packs must be taken for recycling or disposal at an appropriate collection depot by suitably licensed contractors in accordance with government regulations.



Taiwan: Expended battery packs are not considered hazardous waste. Cells and batteries should be recycled at an appropriate collection site in accordance with government regulations.

Japan: Recycling of expended lithium-ion battery packs is regulated by the Wastes Disposal and Public Cleaning Law and the Law for Promotion of Effective Utilization.

Brazil: Expended battery packs should be recycled in accordance to the Natation Solid Waste Policy (PNRS) or CONAMA in compliance with the directives and regulations of the National System of Environmental (SISNAMA).

Malaysia: Lithium-ion cells and batteries are considered scheduled wastes and must be sent to a proper collection treatment, recycling and Disposal Centre; Scheduled Waste Code SW103.

Classification of Waste to comply with Transport Regulations: Expended Lithium-Ion Battery packs are not considered hazardous waste. Lithium-ion battery packs that have been involved in a fire maybe considered hazardous waste and should be marked and classified as such.

Classification of Waste Packaging Material: Under normal use packaging is not consider hazardous and should be disposed of in accordance with local recycling regulations. Packaging that has been

exposed to a damaged leaking cell should be considered hazardous waste and disposed of in accordance to local rules and regulations.



3 REQUIREMENTS

3.1 General Requirements

3.1.1. Nominal Voltage

- The battery nominal operating voltage is 14.4V

3.1.2. Rated Capacity

- The initial capacity is 2850mAh (based on a CV charge of 16.8V±50mV with a current limit of 1400mA and 3000mA discharge to 11.4V @ 25C, within 1 hour of charge).

3.1.3. Initial Impedance

- The internal impedance of a fully charged battery shall be ≤311mΩ when measured across the positive and negative battery terminals at 1kHz at 20°C.

3.1.4. Discharge -20°C to +60°C

- Discharge Temperature Limits: As shown below, $\leq 80\%RH$
- The battery shall be capable of continuous discharge within the Operating Boundary as shown in the graph below.
- Host devices should be designed for a controlled shutdown following battery notification of termination by the battery sending TERMINATE_DISCHARGE alarm, prior to protection circuit cut-off.

Discharge Operating Limits

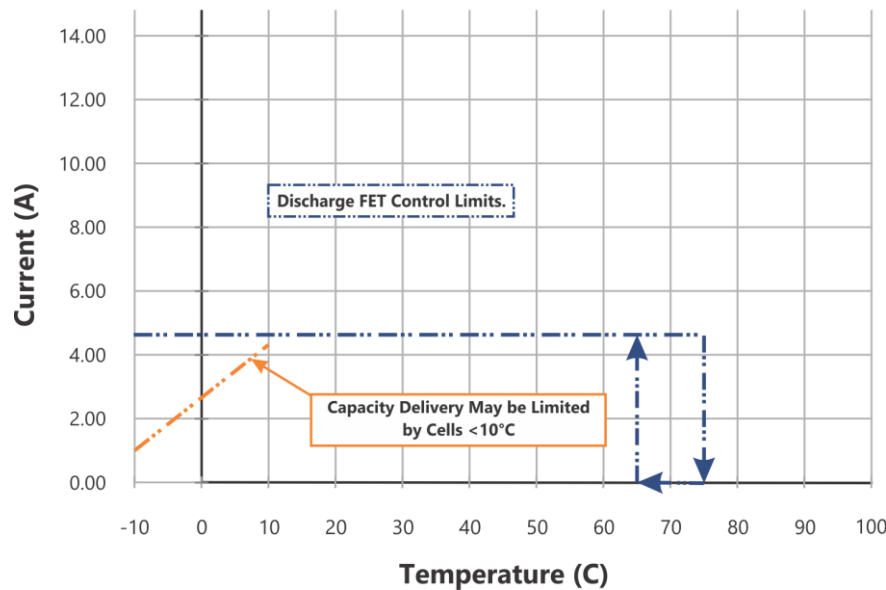

Rate discharge curve@ 25°C

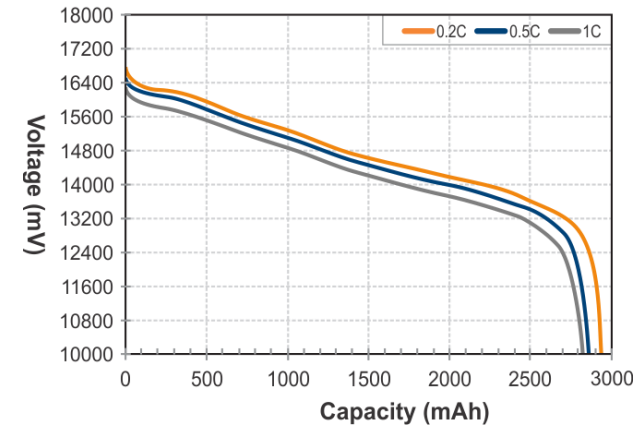

Discharge curve at different temperatures

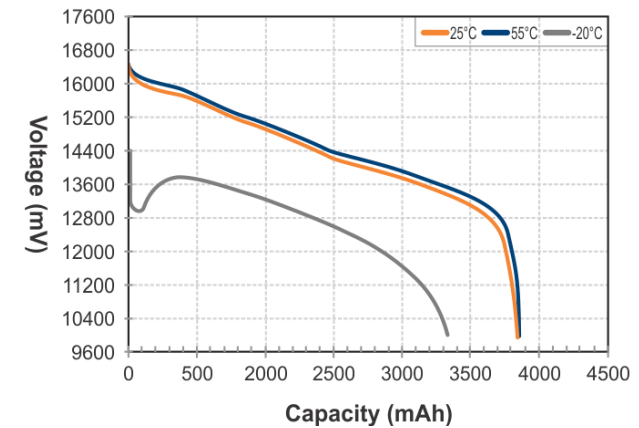

3.1.5. Charge 0°C to 45°C

- Charge Temperature Limits: As Shown below, $\leq 80\%RH$
- The battery shall be capable of continuous charge at 16.8V, as shown in the graph below. A dedicated level II or level III smart battery charger is required to charge the battery. Using this type of charger, the battery will request appropriate charging Voltage and Current from the smart battery charger.
- The FULLY_CHARGED bit in the BatteryStatus() will be set when the charging current tapers down under 200mA while charging at 16.8V.

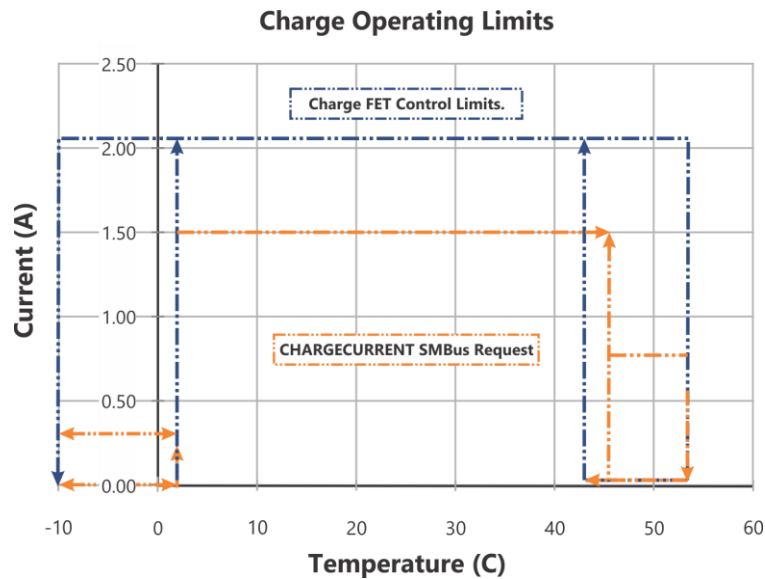

Rate charge curve@ 25°C

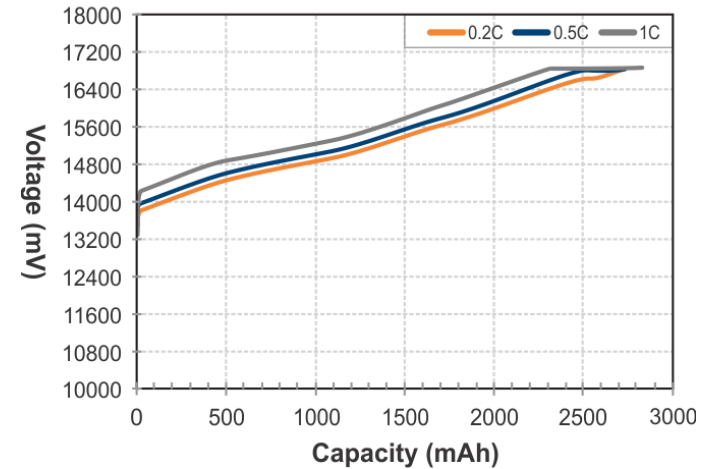

3.1.6. Storage

- Storage Temperature Limits: -20°C to 60°C , $\leq 80\%RH$
- The battery should be stored in an environment with low humidity, free from corrosive gas at a recommended temperature range $< 21^{\circ}\text{C}$. Extended exposure to temperatures above 45°C could degrade battery performance and life.

3.1.7. Terminal Specifications

See Mechanical Drawing for orientation of contacts J1-1,5

TERMINAL	LEGEND	DESCRIPTION
1	(+)	Positive side of battery
2	(C)	SMBus Clock. Internally a $1M\Omega$ resistor is connected between (C) and (-)
3	(D)	SMBus Data. Internally a $1M\Omega$ resistor is connected between (D) and (-)
4	(T)	$300\Omega \pm 5\%$ resistor connected between (T) and (-)
5	(-)	Negative side of battery

- A key slot is also present on each pack for mechanical alignment adjacent to the positive terminal. The SMBus Clock and data lines require separate pull-ups to system logic voltage, NOT the battery voltage. Typically, a $15K\Omega$ pull-up resistor is used, but

please refer to the SMBus Specification for additional info.

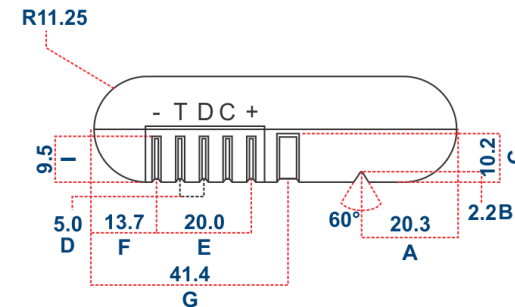

3.2 Fuel-Gauge Electronics

3.2.1. Overview of Operation

- The battery is capable of communicating with host or the charger through the System Management Bus (SMBus). The battery is fully SMBus and SBDS Revision 1.1 compliant. An 8-bit Reduced Instruction Set CPU (RISC) is used to process the core algorithms and perform operations required for battery monitoring. Charge and discharge current, cell and pack voltages, and pack temperature are all measured using an integrated analog to digital converter at 14-bit to 16-bit effective resolution.
- The battery pack uses a system level approach to optimize the performance of the battery. It's primary functions are to provide fuel gauging and software based charge control, and to ensure safe operation throughout the life cycle of the battery.

- The fuel gauge determines the State-Of-Charge (SOC) by integrating the input and output current and using impedance tracking to accurately track the available capacity of the attached battery. To achieve the desired fuel-gauge accuracy, high-performance analog peripherals are used to monitor capacity change, battery impedance, open-circuit voltage and temperature. These factors are continually applied to account for battery non-linearity and environmental conditions. This approach provides the user a meaningful and repeatable capacity measure with minimal risk of overstating run time. Visually, the SOC can be obtained from the four on-pack LED's with push- button activation.
- Charge control is used to provide optimal and safe charging requests to an SMBus level II or level III charger.
- The system has three modes of operation; normal, sleep and shutdown. In normal mode, measurements, calculations, protection decisions and data updates are made on 1 sec intervals. Between these intervals, the electronics enters a reduced power mode. Sleep mode is entered when the system senses no host or charger present. While in this mode, battery parameters continue to be monitored at regular intervals. The system will continue in this mode until it senses host activity (communications or current flow). Shutdown mode occurs when the battery voltage falls below 2.3V/parallel cell group. In this mode, parasitic current is reduced to a minimum by shutting down the micro- controller and all associated circuitry. If this should happen, the battery will require an initial low current

charge to bring the battery voltage back up before normal operation will resume.

- The battery pack block diagram is shown below.

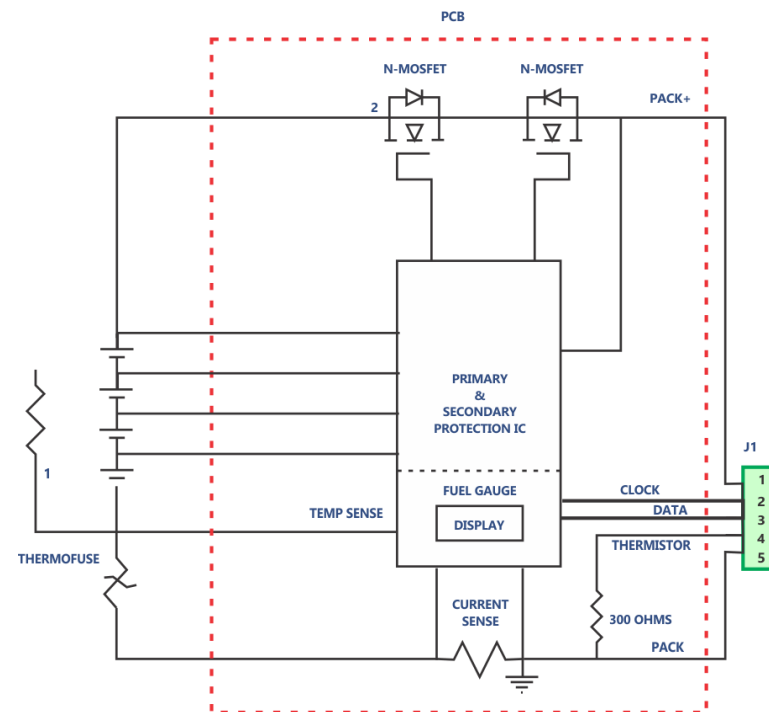



3.2.2. DC Specifications

PARAMETER	LIMITS	REMARKS
Active mode current consumption	<650 μ A	When a host is detected (charging, discharging or communications)
Standby mode current consumption	<140 μ A	When no host activity is detected
Shut-down mode current consumption	<1 μ A	Any cell voltage falls below 2300mV

3.2.3. Measurement Accuracy

3.2.3.1. Voltage

- The voltage measurements have a resolution of 1mV. The absolute accuracy of the reading is $\pm 0.7\%$ over the operating range. Note that measurements are made at the cell stack (not the pack connector). Therefore, internal resistance drops due to the shunt, safety components, and contact resistance are not taken into consideration.

3.2.3.2. Temperature

- The internal pack temperature is measured by an NTC thermistor attached to the cell stack. Temperature readings have a resolution of 0.1 $^{\circ}$ K. The absolute accuracy is $\pm 3^{\circ}$ K over an operating range of -20 $^{\circ}$ C to +80 $^{\circ}$ C.

3.2.3.3. Current

- The current measurements have a resolution of 1mA. The absolute accuracy of the reading is $\pm 0.7\%$ or ± 3 mA whichever is greater over the operating range. A guard band has been imposed around zero current (-3mA to +3mA).

3.2.4. LED Indication

- The battery can directly display the capacity information. The battery capacity is displayed as the relative SOC. Each LED segment represents 25 percent of the full charge capacity. The LED pattern definition is given in the table below. The LED's illuminate for 4 seconds following switch activation. If the battery voltage is too low, there will be no LED indication.





RSOC	LED1	LED2	LED3	LED4	LED5	NOTE
At below 10%						Blinks
11%-20%						Lit for 4 sec when ever switch is pressed
21%-40%						
41%-60%						
61%-80%						
81%-100%						

3.3. SMBus and SBD Parameters

3.3.1. Overview of Operations

The battery is fitted with a microprocessor and associated circuitry for communication with an external host device and/or smart battery charger. Reference should be made to the following specifications when reading this section:

- System Management Bus Specification (Rev1.1, Dec11, 1998) with the exception that it is necessary to wait at least 150uS between battery message transactions.
- Smart Battery Data Specification (Rev1.1, Dec15, 1998)
- Smart battery Charger Specification (Rev1.0, June27, 1996)

3.3.2. SMBus Logic Levels

SYMBOLS	PARAMETERS	LIMITS		UNITS
		MIN	MAX	
V _{il}	Data/Clock input low voltage	-0.3	0.8	V
V _{ib}	Data/Clock input high voltage	2.1	5.5	V
V _{ol}	Data/Clock output low voltage		0.4	V

3.3.3. SMBus Data Protocols

- SMBus Interface complies with SBS Specification Version 1.1. The battery pack includes a simple bi-directional serial data interface. A host processor uses the interface to access various battery pack registers.
- The interface uses a command-based protocol, where the host processor sends the battery address command byte to the battery pack. The command directs the battery pack to either store the next data received to a register specified command byte or output the data specified by the command byte.
-



3.3.4. SMBus Host-to-Battery Message Protocol

The Bus Host communicates with the battery pack using one of three protocols:

- Write Word
- Read Word
- Read Block

3.3.4.1. Write Word

The first byte of a Write Word access is the command code. The next two Bytes are the data to be written. In this example the master asserts the slave device address followed by the write bit. The device acknowledges and the master delivers the command code. The slave again acknowledges before the master sends the data word (low byte first). The slave acknowledges each byte according to the I²C specification, and the entire transaction is finished with a stop condition.

1	7	1	1	8	1	8	1	8	1	1
S	Battery Address	Wr	A	Command Code	A	Data Byte Low	A	Data Byte High	A	P

Write Word Protocol

1	7	1	1	8	1	8	1	8	1	8	1	1
S	Battery Address	Wr	A	Command Code	A	Data Byte Low	A	Data Byte High	A	PEC	A	P

Write Word Protocol w/PEC

SMBus Host (Master)
 Smart Battery (Slave)

3.3.4.2 .Read Word

Reading data is slightly more complex than writing data. First the host must write a command to the slave device. Then it must follow that command with a repeated start condition to denote a read from that device's address. The slave then returns two bytes of data. Note that there is not a stop condition before the repeated start condition, and that a "Not Acknowledge" signifies the end of the read transfer.

1	7	1	1	8	1	1	7	1	1	8	1	8	1	1
S	Battery Address	Wr	A	Command Code	A	S	Battery Address	Rd	A	Data Byte Low	A	Data Byte High	!A	P

Read Word Protocol



1	7	1	1	8	1	1	7	1	1	8	1	8	1	1
S	Battery Address	Wr	A	Command Code	A	S	Battery Address	Rd	A	Data Byte Low	A	Data Byte High	A	PEC !A P

Read Word Protocol w/PEC

SMBus Host (Master)
 Smart Battery (Slave)

3.3.4.3. Block Read

The Block Read begins with a slave address and a write condition. Then it must follow that command with a repeated start condition to denote a read from that device's address. After the repeated start the slave issues a byte count that describes how many data bytes will follow in the message. If a slave had 20 bytes to send, the first byte would be the number 20 (14h), followed by the 20 bytes of data. The byte count may not be 0. A Block Read can transfer a maximum of 32 bytes.

1	7	1	1	8	1	1	7	1	1	
S	Battery Address	Wr	A	Command Code	A	S	Battery Address	Rd	A	...

8	1	8	1	8	1		8	1	1
Byte count =N	A	Data Byte 1	A	Data Byte 2	A	≈	Data Byte N	!A	P

Block Read

1	7	1	1	8	1	1	7	1	1
S	Battery Address	Wr	A	Command Code	A	S	Battery Address	Rd	A

8	1	8	1	8	1		8	1	8	1	1
Byte count=N	A	Data Byte 1	A	Data Byte 2	A	≈	Data Byte N	A	PEC !A	P	

Block Read w/ PEC

SMBus Host (Master)
 Smart Battery (Slave)

3.3.5. SMBus battery-to-Charger Message Protocol

The Smart Battery, acting as an SMBus master will dynamically alter the charger characteristics of the Smart Charger, behaving as an SMBus slave using the SMBus Write Word protocol. Communication begins with the Smart Charge's address, followed by a Command Code and a two bytes value. The Smart Charger adjust its output to correspond with the request.





1	7	1	1	8	1	8	1	8	1	1
S	Charger Address	Wr	A	Command Code	A	Data Byte low	A	Data Byte High	A	P

Battery Broadcast Message for the Charger

1	7	1	1	8	1	8	1	8	1	1
S	Target Address	Wr	A	Battery Address	A	Data Byte low	A	Data Byte High	A	P

Battery Critical Message

1	7	1	1	8	1	8	1	8	1	8	1	1
S	Charger Address	Wr	A	Command Code	A	Data Byte low	A	Data Byte high	A	PEC	A	P

Battery Broadcast Message for the Charger w/PEC

1	7	1	1	8	1	8	1	8	1	8	1	1
S	Target Address	Wr	A	Battery Address	A	Data Byte low	A	Data Byte High	A	PEC	A	P

Battery Critical Message w/PEC

SMBus Host (Master)
 Smart Battery (Slave)

SMBus Host (Master)
 Smart Battery (Slave)

3.3.6. SMBus battery Critical Message Protocol

A Smart Battery to SMBus Host or Smart Charger message is sent using the SMBus Write Word protocol. Communication begins with the SMBus Host's or Smart Battery Charger's address, followed by the Smart Battery's address which replaces the Command Code. The SMBus Host or Smart Charger can now determine that the Smart Battery was the originator of the message and that the following 16 bits are its status.

3.3.7. Host to battery Message (Slave Mode)

The Host acting in the role of bus master uses the read word, write word, and read block protocols to communicate with the battery, operating in slave mode.



Host-to-Battery Messages

Function	Command Code	Description	Unit	Access	Default (POR)
Manufacturer Access()	0x00			r/w	
Remaining Capacity Alarm()	0x01	Remaining Capacity Alarm Threshold	mAh	r/w	870
Remaining Time Alarm()	0x02	Remaining Time Alarm Threshold.	minutes	r/w	10
Battery Mode()	0x03	Battery Operational Modes.	Bit flags	r/w	0x0081
At Rate()	0x04	This function is the first half of a two-function call-set used to set the At Rate value used in calculations made by the At Rate Time To Full(), At Rate Time To Empty(), and At Rate OK() functions.	mA	r/w	0
At Rate Time To Full()	0x05	Returns the predicted remaining time to fully charge the battery at the At Rate() value.	minutes	r	65535
At Rate Time To Empty()	0x06	Returns the predicted remaining operating time if the battery is discharged at the At Rate() value.	minutes	r	65535
At Rate OK()	0x07	Returns a Boolean value that indicates whether or not the battery can deliver the At Rate value of additional energy for 10 seconds. If the At Rate() value is zero or positive, the At Rate OK() function will ALWAYS return TRUE.	Boolean	r	1
Temperature()	0x08	Returns the pack's internal temperature.	0.1 °K	r	

Function	Command Code	Description	Unit	Access	Default (POR)
Voltage ()	0x09	Returns the battery's voltage (measured at the cell stack)	mV	r	
Current ()	0x0a	Returns the current being supplied (or accepted) through the battery's terminals.	mA	r	0
Average Current ()	0x0b	Returns a rolling average based upon the last 64 samples of current.	mA	r	0
Max Error ()	0x0c	Returns the expected margin of error.	percent	r	100
Relative State Of Charge ()	0x0d	Returns the predicted remaining battery capacity expressed as a percentage of Full Charge Capacity().	percent	r	0
Absolute State Of Charge ()	0x0e	Returns the predicted remaining battery capacity expressed as a percentage of Design Capacity().	percent	r	0
Remaining Capacity ()	0x0f	Returns the predicted remaining battery capacity.	mAh	r	0
Full Charge Capacity ()	0x10	Returns the predicted battery capacity when fully charged.	mAh	r	
Run Time To Empty()	0x11	Returns the predicted remaining battery life at the present rate of discharge.	minutes	r	65535
Average Time To Empty()	0x12	Returns the rolling average of the predicted remaining battery life.	minutes	r	65535
Average Time To Full()	0x13	Returns the rolling average of the predicted remaining time until the battery reaches full charge.	minutes	r	65535
Charging Current()	0x14	Returns the battery's desired charging rate.	mA	r	4000

Host-to-Battery Messages (cont.)

Function	Command Code	Description	Unit	Access	Default (POR)
Charging Voltage()	0x15	Returns the battery's desired charging voltage.	mV	r	12600
Battery Status()	0x16	Returns the battery's status word.	Bit flags	r	0x2C0
Cycle Count()	0x17	Returns the number of charge/discharge cycles the battery has experienced. A charge/discharge cycle is defined as: an amount of discharge approximately equal to the value of Design Capacity.	cycles	r	0
Design Capacity()	0x18	Returns the theoretical capacity of the new battery.	mAh	r	8700
Design Voltage()	0x19	Returns the theoretical voltage of a new battery.	mV	r	10800
Specification Info()	0x1a	Returns the version number of the SBDS the battery pack supports, as well as voltage and current scaling information.	word	r	0x0031
Manufacturer Date()	0x1b	Returns the date the electronics were manufactured.	word	r	
Serial Number()	0x1c	Returns the electronics serial number.	number	r	
Manufacturer Name()	0x20	Returns a character array containing the manufacture's name.	string	r	SES
Device Name()	0x21	Returns a character array that contains the battery's name.	string	r	SE-2054-1
Device Chemistry()	0x22	Returns a character array that contains the battery's chemistry.	string	r	LION
Manufacturer Data()	0x23	Returns data specific to the manufacture.		r	

3.3.8. Battery to charger Messages (Master Mode)

The battery, acting in the role of a bus master, uses the write word protocol to communicate with the charger, operating in slave mode. If the CHARGER_MODE bit in Battery Mode() is clear, the Battery will broadcast Charger request information every 10 to 60 second.

Battery-to-Charger Messages

Function	Command Code	Description	Unit	Access
Charging Current()	0x14	Sends the desired charging rate to the battery charger	mA	W
Charging Voltage()	0x15	Sends the desired charging voltage to the battery charger	mV	W

3.3.9. Critical Messages (Master Mode)

Whenever the Battery detects a critical condition, it takes the role of a bus master and sends Alarm Warning() message to the Host and/ or Charger. The Battery broadcasts the Alarm Warning() message at 10 second intervals until the critical condition(s) has been corrected.

Battery Critical Messages

Function	Command Code	Description	Unit	Access
Alarm Warning()	0x16	This message is to the host and/or charger to notify them that one or more alarm conditions exist.	word	W

Alarm Bit Definitions

Bit	Battery Status	Set When:	Action When Set:	Cleared When:
15	OVER_CHARGE_ALARM	Remaining Capacity() exceeds <i>Full Charge Capacity()</i> + 300mAh .	Stop charging.	A continuous discharge of $\geq 300\text{mAh}$.
14	TERMINATE_CHARGE_ALARM	Primary Charge Termination, Cell Over-Voltage (COV), Over-Current Charge (OCC), Over-Temp Charge (OTC) conditions. COV = 4300mV OCC = 2000mA OTC = 58°C	Stop charging.	Relative State of Charge() $\leq 95\%$, COV, OCC or OTC recovery threshold. COV recovery $\leq 4150\text{mV}$ OCC recovery $\leq 200\text{mA}$ for 70sec OTC recovery $\leq 56^\circ\text{C}$
13	Reserved			
12	OVER_TEMP_ALARM	Over-Temp Charge (OTC) or Over-Temp discharge (OTD) condition. OTC=58°C OTD=75°C	Appropriate FET will be disabled.	OTC or OTD recovery threshold. OTC recovery =56°C OTD recovery =65°C

Bit	Battery Status	Set When:	Action When Set:	Cleared When:
11	TERMINATE_DISCHARGE_ALARM	Relative State of Charge() $\leq 0\%$, Cell Under-Voltage (CUV) Over-Current Discharge (OCD), Over-Temp Discharge (OTD) conditions CUV = 2400mV OCD = -4250mA OTD = 75°C	Stop discharging.	Relative State Of Charge() $\geq 1\%$, CUV, OCD or OTD recovery threshold. CUV recovery $\geq 3000\text{mV}$ OCD recovery $\geq -200\text{mA}$ for 70sec OTD recovery $\leq 65^\circ\text{C}$
10	Reserved			
9	REMAINING_CAPACITY_ALARM (User settable)	Remaining Capacity() < Remaining Capacity Alarm().	User defined.	Remaining Capacity Alarm() = 0 or $\text{Is} \leq \text{Remaining Capacity}()$.
8	REMAINING_TIME_ALARM (User settable)	Average Time To Empty() < Remaining Time Alarm().	User defined.	Remaining Time Alarm() = 0 or $\leq \text{Average Time To Empty}()$.

Status Bit Definitions

Z	Battery Status	Set When:	Action When Set:	Cleared When:
7	INITIALIZED		None.	
6	DISCHARGING	Battery is not in charge mode.	None.	Battery is in charging mode.
5	FULLY CHARGED	When the battery detects a primary charge termination.	Stop charging.	Relative State Of Charge() $\leq 95\%$.
4	FULLY DISCHARGED	Relative State of Charge() $\leq 0\%$.	Stop discharging.	Relative State Of Charge() $\geq 20\%$.

3.3.10. Pack Calibration cycle

The fuel-gauge uses the Impedance Track Technology to measure and calculate the available charge in battery cells. The achievable accuracy is better than 1% error over the lifetime of the battery. Max Error increases by 1% in 20 cycles, e.g., only occasionally is a full charge/discharge learning cycle required to maintain high accuracy.

3.4. Protection Electronics

3.4.1. Overview of Operations

Electronic circuitry is permanently connected within the battery pack to prevent damage if either the charger or host device fails to function correctly. The circuitry also protects the battery if an illegal current source is placed across the battery terminals, or an illegal load is connected. Redundant levels of protection have been implemented (the primary protection levels are auto-resettable and the secondary are non-resettable).

3.4.2. Charge Protection

Over-Voltage:

- The primary protection circuit will prevent the battery from charging if any cell voltage $\geq 4300\text{mV}$. Then, once all cell voltages are $\leq 4150\text{mV}$, it will allow charging again.
- The secondary protection circuit will prevent the battery from charging if any cell voltage $\geq 4.35\text{V} \pm 0.05\text{V}$ by blowing a power path logic fuse. The fuse is non-re-settable rendering the battery pack non-functional.

Over-temp:

- The primary protection circuit also provides over-temperature protection and will prevent the battery from charging at temperatures $\geq 54^\circ\text{C}$ (see paragraph 3.1.5 for Charge Current() request). Then, once the battery temperature has cooled to $\leq 45^\circ\text{C}$, it will again allow charging.

Over-Current:

- The primary protection circuit also provides continuous over-current protection and will prevent the battery from charging at Current() $\geq 1.4\text{A}^*$. Then, once the Average Current() $\leq 200\text{mA}$ for 70sec, the battery will re-test the over-current condition, and again allow charging.

*Note: Current values vary time to time. Check SDS with SES®



3.4.3. Discharge Protection

Under-Voltage:

- The primary protection circuit will prevent the battery from being further discharged once any cell voltage reaches $\leq 2900\text{mV}$. Then, once all cell voltages are $\geq 3150\text{mV}$, it will allow discharge again.

Over-temp:

- The primary protection circuit also provides over-temperature protection and will prevent the battery from discharging at temperatures $\geq 75^\circ\text{C}$. Then, once the battery temperature has cooled to $\leq 65^\circ\text{C}$, it will again allow discharging.
- If the battery reaches 85°C for any reason the secondary protection circuit will blow the in-line power path logic fuse. The fuse is non-re-settable rendering the battery pack non-functional.

Over-Current:

- The primary protection circuit also provides continuous over-current protection and will prevent the battery from discharging at $\text{Current}() \leq 3.0\text{A}$. Then, Once the Average Current() $\geq -200\text{mA}$ for 70sec, the battery will re-test the over-current condition, and again allow discharging.

3.4.4. Short Circuit Protection

- The primary protection circuit will prohibit the discharge of the battery if a short-circuit is placed across the battery+ / - terminals. Then, once the Average Current() $\geq -1\text{mA}$ for 70sec, the battery will re-test the short-circuit condition, and again allow discharging.
- The pack is design to withstand reasonable in-rush currents without resetting the electronics and without interrupting the discharge cycle. The following graph illustrates the short-circuit/in-rush set points as implemented:

Inrush Current Protection

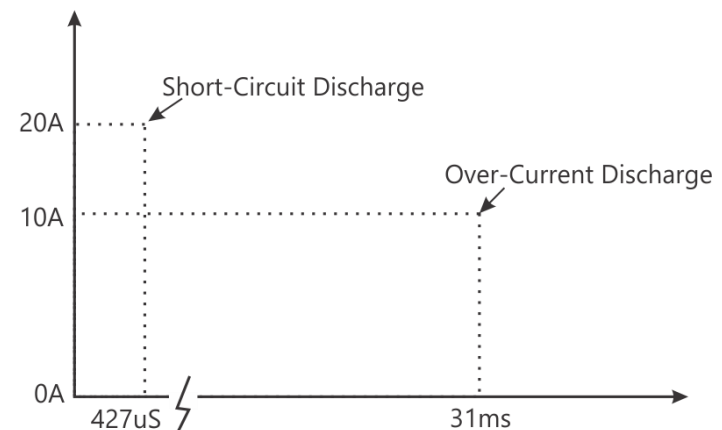



3.5. Passive Safety Protection

3.5.1. Overview of Operations

The battery pack is fitted with additional components to protect it against abusive charge and discharge conditions. These are in addition to the electronic protection.

3.5.2. Thermal Fuse

A Thermal Fuse is fitted in series with the charge/ discharge path to protect the battery from over temperature. This device goes open circuit if the cell case temperature reaches the fuse's temperature rating of 93°C (+0°C, -5°C). The fuse is non-re-settable rendering the battery pack non-functional.

3.6. Mechanical Specifications

3.6.1. Weight 0.280Kg, approximately

3.6.2. Mating Connector

The recommended interconnection mating male connector is AMP/ TE part no.5787428-1 or 5787421-1

3.6.3. Packing

The batteries are packaged in bulk per current regulations.

3.7. Environmental/Safety Specifications

3.7.1. EMC and Safety

The battery complies with the following:

- EMC Directive 2004/108/EC
- Low Voltage Directive 2006/95/EC
- Battery Recycling Directive 2006/66/EC as amended
- RoHS Directive 2011/65/EU

The battery has been tested in accordance with the UN Manual of tests and Criteria part III subsection 38.3 (ST/SG/AC.10/11/Rev.3) - more commonly known as the UN T1-T8 Transportation tests and has been found to comply with the stated criteria. [USDOT-E7052]

The battery has the following approvals and the pack will be labeled according:

- EN/ IEC 61000-6-3: 2010
- EN/ IEC 61000-6-1: 2016
- EN/ IEC 62281: 2016
- EN/IEC 62133-2:2017
- CE
- BIS/ IS16046-2:2018
- REACH
- RoHS



3.8. Reliability

3.8.1. Life Expectancy

Given normal storage & usage, user can expect the battery to deliver 2280mAh or more after 1000 charge/discharge cycles where the charge phase is CC/CV C/3, 16.8±0.05V and the discharge is C/3 down to 3.0V/Cell at 25°C.

Cycle life curve@ 25°C

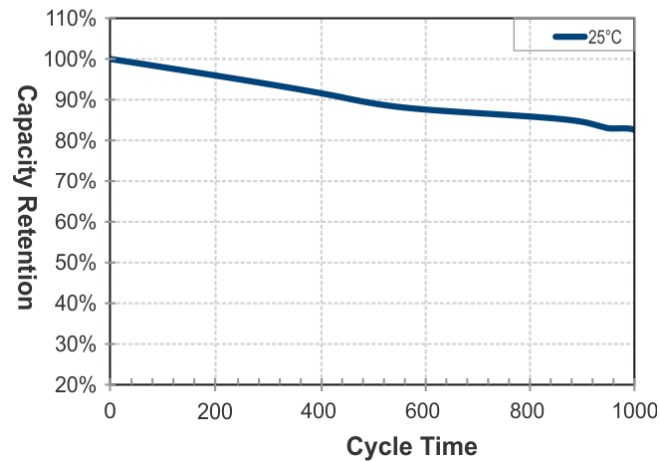

High temperature cycle life curves

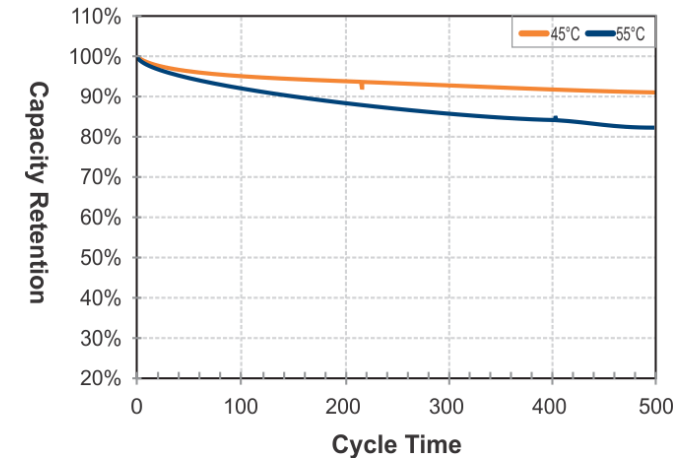

3.8.2. Warranty

Sealed Energy Systems maintains a high quality standard. All products are warranted against defects in workmanship, material and construction. The warranty period is one (1) year from the date of shipment from Sealed Energy Systems.





3.8.3. Shelf Life

The batteries are shipped from Sealed Energy Systems with between 20% and 30% rated capacity and this provides a minimum of 6 months' shelf life, when stored at 25°C. If the storage temperature exceeds 25°C over the 6-month period, then the shelf life will be reduced and provisions should be made to recharge the battery periodically.

In order to prevent parasitic drain on the battery, the electronics will go into a shutdown mode if any cell voltage $\leq 2300\text{mV}$. If this should happen, the battery pack will require an initial low charge to activate the electronics prior to the implementation of the normal charge. Any SMBus version 1.0, or higher, compatible charger is capable of providing this initial pre-charge.

Statement of Confidentiality

This information is descriptive only. No representation, guarantee or warranty of merchantability or fitness for purpose is made or implied. Specifications are subject to change without notice.



4.0. Mechanical Drawing

